

# Clarke®

## WOODWORKER



# 18" VARIABLE SPEED WOOD LATHE

## MODEL NO: CWL460

PART NO: 6501661

## OPERATION & MAINTENANCE INSTRUCTIONS

UK  
CA | CE



ORIGINAL INSTRUCTIONS

GC0621

---

## INTRODUCTION

---

Thank you for purchasing this CLARKE 18" Variable Speed Wood Lathe.

Before attempting to operate the machine, it is essential that you read this manual thoroughly and carefully follow all instructions given. In doing so you will ensure the safety of yourself and that of others around you, and you can also look forward to the product giving you long and satisfactory service.

---

## GUARANTEE

---

This CLARKE product is guaranteed against faulty manufacture for a period of 12 months from the date of purchase. Please keep your receipt as proof of purchase.

This guarantee is invalid if the product is found to have been abused or tampered with in any way, or not used for the purpose for which it was intended.

Faulty goods should be returned to their place of purchase, no product can be returned to us without prior permission.

This guarantee does not affect your statutory rights.

---

## SPECIFICATIONS

---

Weight	33 kg
Dimensions (L x W x H)	990 x 250 x 410 mm
Speed	650 - 3800 rpm (Variable)
Distance Between Centres	460 mm
Turning Capacity	304 mm
Tool Rest	148mm
Headstock Arbour Thread Size	1" 8 RH thread
IP (Ingress Protection) Rating	IP 54
Motor Voltage/Frequency	230V / 50Hz
Rated Input Wattage	550 W
Sound Pressure Level (Lp)	No load 61.3 / loaded 78.7 dB(A)
Sound Power Level Measured (Lw)	No load 74.3 / loaded 91.7 dB(A)

---

## SAFETY WARNINGS

---



**CAUTION: FAILURE TO FOLLOW THESE PRECAUTIONS COULD RESULT IN PERSONAL INJURY, AND/OR DAMAGE TO PROPERTY.**

---

### WORK ENVIRONMENT

1. Keep the work area clean, tidy and well lit. Cluttered and dark areas invite accidents.
2. **DO NOT** operate power tools in explosive atmospheres, such as in the presence of flammable liquids, gases or dust. Power tools create sparks which may ignite the dust or fumes.
3. Keep children and bystanders away while operating a power tool. Anyone entering the work area must wear personal protective equipment. Distractions can cause you to lose control and fragments of work may fly away and cause injury.
4. Store power tools properly when not in use. Abrasive products should be stored in a dry, secure place out of the reach of children.
5. Please read these instructions carefully and retain for future reference.

### ELECTRICAL SAFETY

1. Power tool plugs must match the outlet. **NEVER** modify the plug in any way. **DO NOT** use adapter plugs with earthed (grounded) power tools. Unmodified plugs and matching outlets will reduce the risk of electric shock.
2. This machine is designed for indoor environments and must not be used for other purposes. **DO NOT** expose power tools to rain or wet conditions. Water entering a power tool will increase the risk of electric shock.
3. **DO NOT** abuse the power cable. **NEVER** use the cable for carrying, pulling or unplugging the power tool. Keep the cable away from heat, oil, sharp edges or moving parts. Damaged or entangled cables increase the risk of electric shock.
4. Position the power cable so that it cannot be inadvertently pulled or pinched, and where it does not cause a trip hazard.
5. Before cleaning or maintenance operations, always unplug the machine from the power supply.

## PERSONAL SAFETY

1. Stay alert, watch what you are doing and use common sense when operating a power tool. **DO NOT** use a power tool while you are tired or under the influence of drugs, alcohol or medication. A moment of inattention while operating power tools may result in personal injury.
2. Use personal protective equipment. **ALWAYS** wear eye protection. Safety equipment such as dust mask, non-skid safety shoes, hearing protection and a workshop apron capable of stopping small abrasive or workpiece fragments.
3. **AVOID** accidental starting. Ensure the switch is in the off position before plugging in. Plugging in power tools that have the switch on invites accidents.
4. Remove any adjusting key or drift rod before turning the power tool on. A wrench or drift rod left attached to a rotating part of the power tool may result in personal injury.
5. **DO NOT** overreach. Keep proper footing and balance at all times. This enables better control of the power tool in unexpected situations.
6. Keep your hair and clothing away from moving parts. Loose clothes, jewellery or long hair can be caught in moving parts.
7. Regularly clean the power tool's air vents. The motor fan will draw dust inside the housing and accumulation of material could cause electrical hazards.
8. **AVOID** operator fatigue. Stop the power tool at regular intervals for a short break to rest hands and arms.
9. Maintain your tools. Keep all handles and grips dry and clean.
10. If the machine requires repair, always contact your CLARKE dealer. Always insist on original spare parts. Repairs carried out by unauthorized persons may be dangerous and invalidate the guarantee.
11. This machine must only be used by adults. Children should not be allowed to play with this appliance.

## POWER TOOL USE AND CARE

1. **DO NOT** force the machine. Use the correct power tool for your application. It will do a better and safer job at the rate for which it was designed.
2. **DO NOT** use the power tool if the switch does not turn it on and off. Any power tool that cannot be controlled with the switch is dangerous and must be repaired.

3. Disconnect the power tool from the power supply before making any adjustments, changing accessories, or storing the tool. These measures will reduce the risk of the power tool starting accidentally.
4. Store power tools out of the reach of children and **DO NOT** allow persons unfamiliar with the tool or these instructions to operate the power tool. Power tools are potentially dangerous in the hands of untrained users.
5. Maintain power tools in top condition. Keep tools/ machines clean for the best and safest performance. Check for misalignment or binding of moving parts, broken parts, or any condition that may affect the power tool's operation. If damaged, have the power tool repaired before use. Many accidents are caused by poorly maintained power tools.
6. Use recommended accessories. The use of improper accessories could be hazardous.
7. Machine cleanliness. **DO NOT** allow the ventilation slots in the machine to become blocked with dust.
8. Check the power tool for damage before using the machine. Any damaged part should be inspected to ensure that it will operate properly and perform its intended function. Check for alignment of moving parts, breakage of parts, mountings, and any other condition that may affect the machine's operation. Any damage should be properly repaired or the part replaced. If in doubt, **DO NOT** use the machine. Consult your local CLARKE dealer.

## SERVICING

1. When necessary, have your power tools serviced or repaired by a qualified person using identical replacement parts. This will ensure that the safety of the power tool is maintained.

## ADDITIONAL PRECAUTIONS FOR WOOD LATHES



**WARNING: DUST GENERATED FROM CERTAIN MATERIALS CAN BE HAZARDOUS TO YOUR HEALTH. ALWAYS OPERATE THE LATHE IN A WELL VENTILATED AREA. USE A DUST COLLECTION SYSTEM WHENEVER POSSIBLE.**

1. **ALWAYS** familiarise yourself with wood lathes and turning techniques before using the machine. If there is any doubt whatsoever you should consult a qualified person.
2. **ALWAYS** store chisels safely when you have finished with the machine.
3. **CAUTION:** This machine is designed for use with woodturning chisels only.
4. **NEVER** attempt to turn a workpiece unless a suitable support is used.





5. **ALWAYS** stop the lathe before removing workpieces, work supports or swarf from the table.
6. **ALWAYS** be sure that the workpiece is securely locked in position
7. **ALWAYS** keep hands and fingers away from the moving workpiece.

---

## SAFETY SYMBOLS

---

The following safety symbols may be found on the machine.

	Fully read this manual and safety instructions before use		Eye protection should be worn
	Ear protection should be worn		Dust mask should be worn
	Indoor Use Only		

---

## ENVIRONMENTAL PROTECTION

---

Recycle unwanted materials instead of disposing of them as waste. All unwanted accessories and packaging should be sorted and taken to a recycling centre for disposal in a manner which is compatible with the environment.

### ENVIRONMENTAL RECYCLING POLICY



Through purchase of this product, the customer is taking on the obligation to deal with the WEEE in accordance with the WEEE regulations in relation to the treatment, recycling & recovery and environmentally sound disposal of the WEEE.

In effect, this means that this product must not be disposed of with general household waste but according to the laws governing Waste Electrical and Electronic Equipment (WEEE) at a recognised disposal facility.

## ELECTRICAL CONNECTIONS



**WARNING! Read these electrical safety instructions thoroughly before connecting the product to the mains supply.**

Before switching the product on, make sure that the voltage of your electricity supply is the same as that indicated on the rating plate. This product is designed to operate on 230VAC 50Hz. Connecting it to any other power source may cause damage.

This product may be fitted with a non-rewireable plug. If it is necessary to change the fuse in the plug, the fuse cover must be refitted. If the fuse cover becomes lost or damaged, the plug must not be used until a suitable replacement is obtained.

If the plug has to be changed because it is not suitable for your socket, or due to damage, it should be cut off and a replacement fitted, following the wiring instructions shown below. The old plug must be disposed of safely, as insertion into a mains socket could cause an electrical hazard.

If the colours of the wires in the power cable of this product do not correspond with the markings on the terminals of your plug, proceed as follows.

- The **Blue** wire must be connected to the terminal which is marked **N** or coloured **Black**.
- The **Brown** wire must be connected to the terminal which is marked **L** or coloured **Red**.
- The **Yellow and Green** wire must be connected to the terminal which is marked **E** or  or coloured **Green**.

**Plug must be BS1363/A approved.**

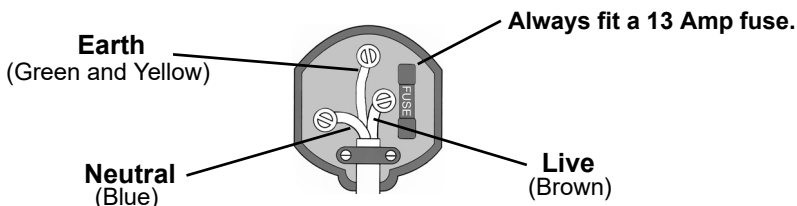

**Ensure that the outer sheath of the cable is firmly held by the clamp**

We strongly recommend that this machine is connected to the mains supply via a Residual Current Device (RCD)

If in any doubt, consult a qualified electrician. **DO NOT** attempt any repairs yourself.

## OVERVIEW

Ensure the wood lathe and its components suffered no damage during transit and that all components are present. Should any loss or damage be apparent, please contact your CLARKE dealer immediately.

The following components are supplied with the lathe assembly.

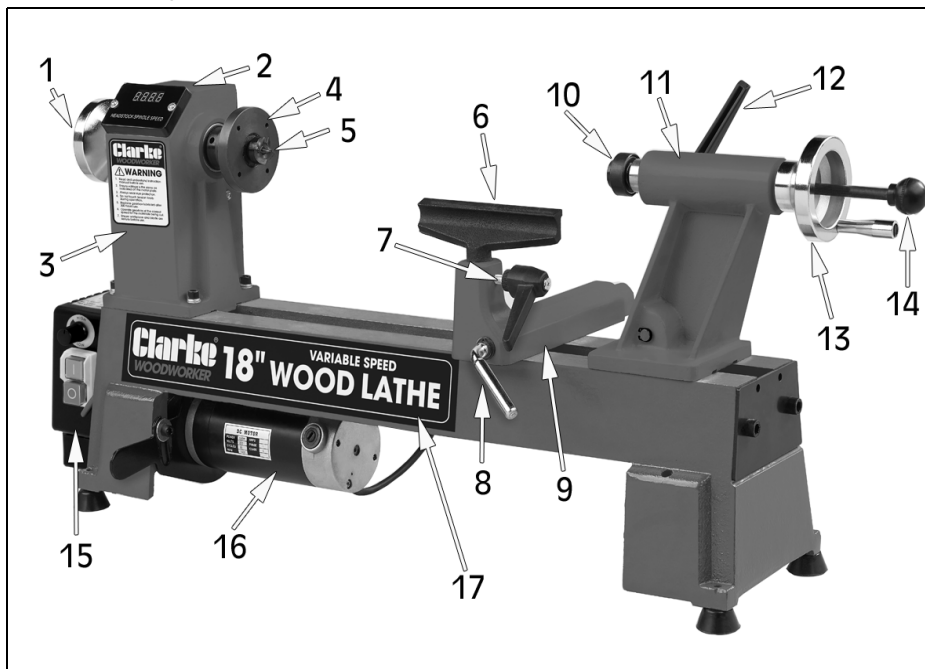

Item	Description
1	Handwheel
2	LED Variable Speed Display
3	Headstock
4	Faceplate
5	Headstock Centre Spur
6	Tool Rest
7	Tool Rest Locking Handle
8	Tool Rest Base Locking Handle
9	Tool Rest Base

Item	Description
10	Tailstock Centre Cup
11	Tailstock
12	Tail Axis Locking Handle
13	Tail Axis Adjusting Wheel
14	Drift Rod
15	On/Off & Speed Control
16	Motor
17	Bed
18	3 x Hex Keys (3mm,6mm,8mm) Not Shown



1. Fit the tailstock centre cup into the tail axis.

**NOTE:** To detach the tailstock centre cup, place the drift rod into the adjusting wheel as far as it goes and give it a tap.

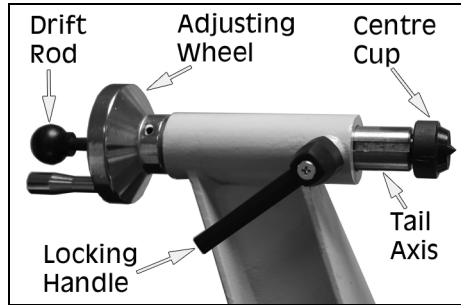

2. Fit the tool rest into the tool rest base. Adjust to the required height and position using the rest locking handle and base locking handle.

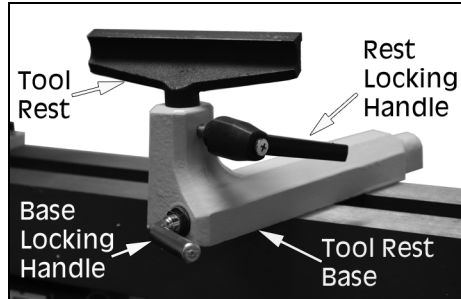

3. Install the headstock faceplate by screwing it onto the headstock spindle, using the drift rod as a counter lever. Lock the faceplate into place using the 2 x 3mm hex grub screws.

**NOTE:** The faceplate has 4 screw holes evenly spaced. These are for securing workpieces that do not require the tailstock for support.

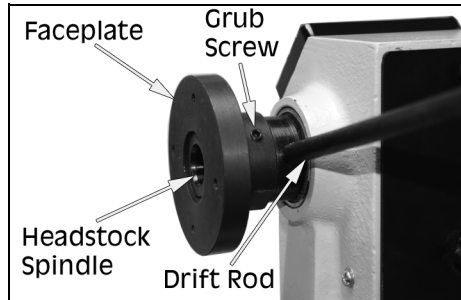

4. Install the headstock centre spur by placing it into the headstock spindle as shown

**NOTE:** To detach the headstock centre spur, place the drift rod into the hand wheel as far as it goes and give it a tap.

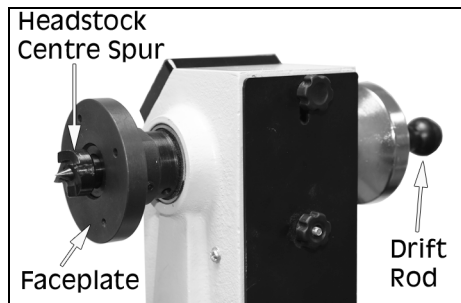

## OPERATION

1. Always rotate the workpiece by hand before turning on the motor and check it does not strike the tool/tool rest.
2. Ensure the tool rest and tailstock are securely locked in position before starting work.
3. Always position the tool-rest just above the centre-line of the lathe.
4. Press the green push-button (I) to start the lathe and adjust the speed using the speed control knob.

**NOTE:** Always use the lowest speed when starting a new workpiece, see Adjusting The Belt Position on page 11.

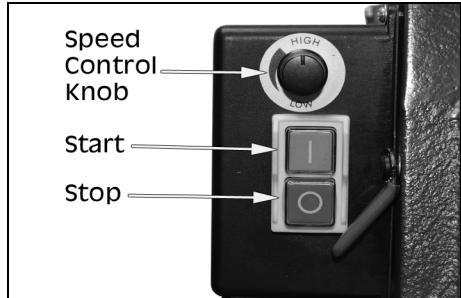

5. The headstock spindle speed can be monitored on the LED display mounted on top of the headstock.
6. Avoid turning timber which has splits or substantial knots or voids and take special care if these are discovered.
7. When turning, always roughly turn the work to a round form at slow speed.
8. Take care that the turning tools do not bite suddenly into the workpiece.



## ADJUSTING THE BELT POSITION

The lathe is fitted with a 3-step pulley assembly, which allows for a range of speeds as shown.

Change the pulley range as follows.

**NOTE:** Make sure that the lathe is unplugged from the power supply.

1. Unlock the control box and swing to the side for access to the motor pulley.
2. Unscrew the rear belt door on the rear of the headstock for access to the drive pulley.
3. Loosen the lock screw that is holding the motor plate using the 6mm hex key. Allowing the motor plate to swivel upwards.
4. Move the belt to the required pulley, as shown in the diagram above.

**NOTE:** Always go from the large pulley to the small pulley

5. After moving the belt, tighten the motor pulley by swiveling the motor plate downwards and tightening the locking screw.
6. Turn on the lathe to make sure the belt is running consistently in its parallel grooves on the pulleys.

**WARNING: KEEP HANDS AND ANY MATERIAL CLEAR OF ROTATING PULLEYS AND BELT**

7. If belt is running smoothly, then turn power off, reattach the control box and rear belt door.

### Speed Chart

A = 650-1430 RPM

B = 1240-2790 RPM

C = 1600-3800 RPM

Headstock



Pulley  
Motor

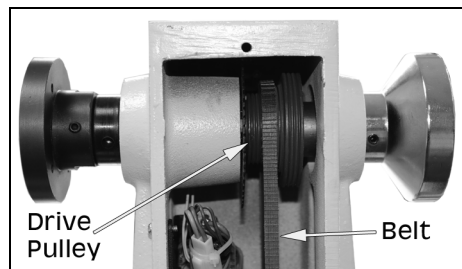
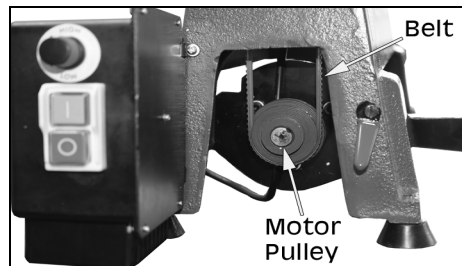
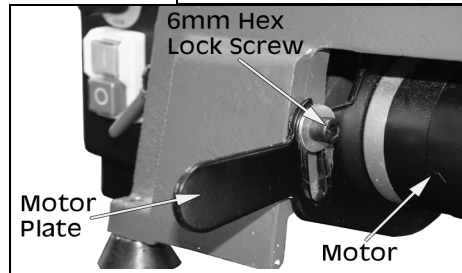

---

# MAINTENANCE

---

For maximum performance, it is essential that the machine is properly maintained. Always inspect before use. Any damage should be repaired and faults rectified. The machine requires very little maintenance other than the following guidelines.

**IMPORTANT: Disconnect from mains power before cleaning.**

1. Vacuum clean any dust or shavings that accumulate in or on the motor.
  2. Check all cables periodically and ensure that they are in good condition and not cracked.
  3. Check the tightness of the mounting bolts.
  4. Check the drive belt for wear and replace if it is frayed or otherwise damaged.
  5. Periodically lubricate the tail-stock, screw threads with engine oil such as SAE20 or SAE30 grade if they become stiff to use.
  6. Lightly lubricate the tail-stock and tool-post locking handles with oil if they become difficult to use.
- The ball bearings in the headstock and tail-stock spindles are greased and permanently sealed at the factory and require no further lubrication.

## REPLACING THE BELT, SPINDLE OR BEARINGS

**NOTE: Numbers in brackets refer to the Parts Diagram on pages 14-16.**

To change the Drive Belt (53), Headstock Spindle (14) or Bearings (4) undertake the following steps.

1. Remove the rear belt door (7) and knob (8).
2. Loosen the two 3mm hex screws (2) and unscrew the hand wheel (1) to remove.

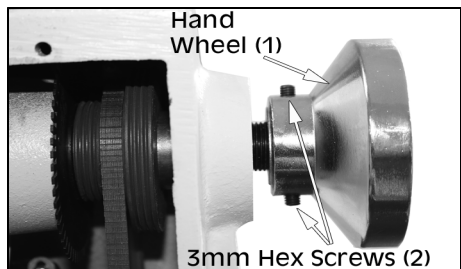

3. Loosen the 3mm hex screw (69) on the drive pulley (52).

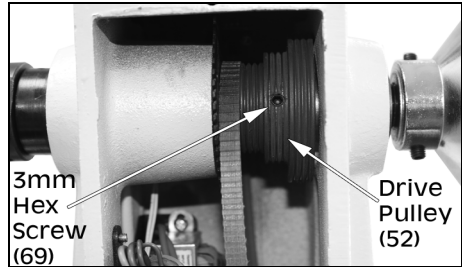

4. Tap out the spindle (14) using a mallet.

**NOTE:** If you don't have a mallet, place a block of wood against the spindle and tap with a hammer.

5. To get the spindle completely out, use a flat head screwdriver to tap it the rest of the way.

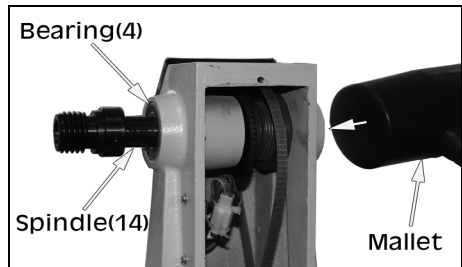

**NOTE:** Be careful not to damage the bearings or the threads.

6. Replace the bearings, spindle or belt as required.

**BELT:** You need only to move the spindle enough to slide a new belt on.

**SPINDLE:** You must knock the spindle completely out through both bearings.

**BEARINGS:** After removal of the spindle, completely knock out the bearings from the inside of the headstock. This is best accomplished by inserting a long rod or screwdriver through one bearing inside the headstock toward the opposite bearing, tap firmly to remove the bearing from the casting. Do the same for the second bearing. Please be aware not to damage the retainer rings (13) when tapping out the bearing. Reassemble the new bearings by tapping them into place from the outside and replace spindle.

**NOTE:** You may have to loosen the motor plate screws (44, 45 & 46) to reinstall the drive pulley (52), spindle collar (3) and belt (53).

7. Reinstall the hand wheel (1) and 3mm hex set screws (2).

**NOTE: DO NOT** tighten the hand wheel against the bearings

8. Tighten the pulley 3mm hex screw (69) and close the rear belt door (7)

Please refer to TROUBLESHOOTING on page 17. If you are unable to rectify any faults, please contact your local dealer or CLARKE International Service Department on 0208 988 7400 for assistance.

# COMPONENT PARTS DIAGRAM

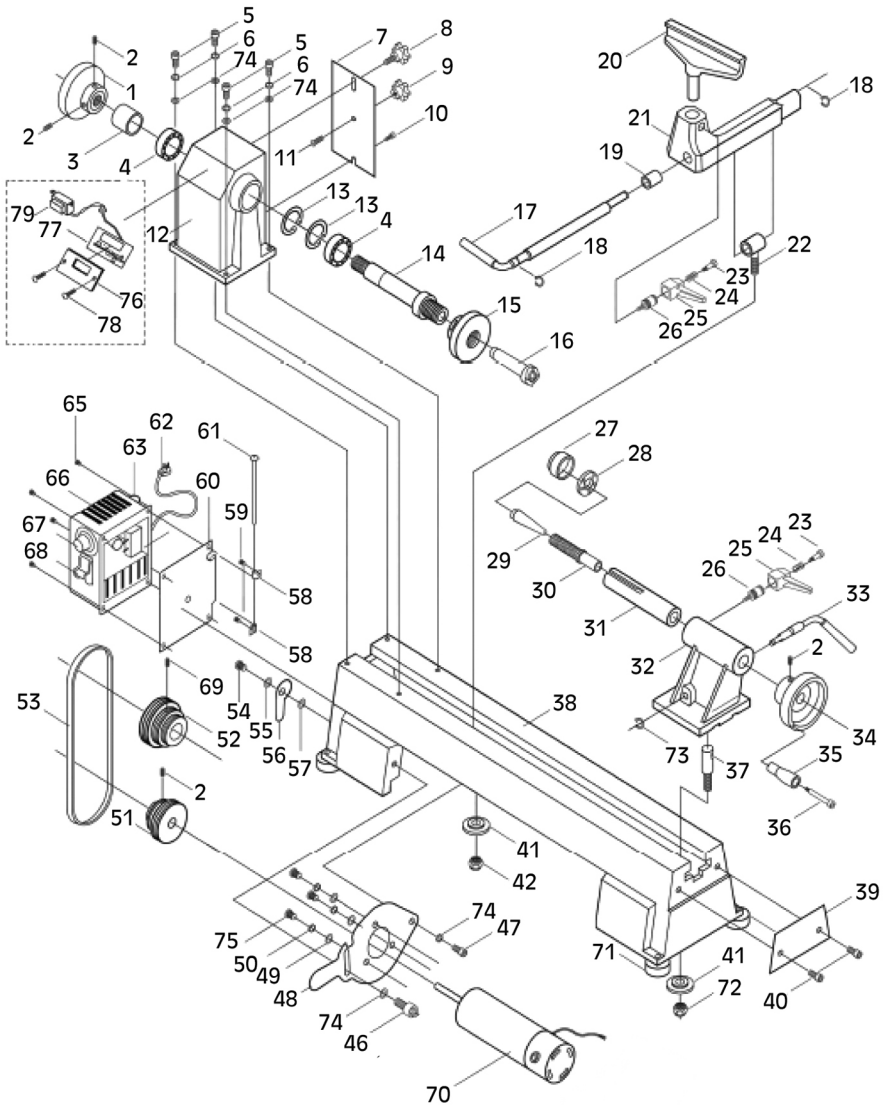



## COMPONENT PARTS LIST

PART NO	DESCRIPTION	PART NO	DESCRIPTION
1	Hand Wheel	31	Tail Axis
2	Hex Socket Screw M6 x 12	32	Tailstock
3	Collar Spindle	33	Eccentric Axis
4	Ball Bearing 80105	34	Adjusting Wheel
5	Hex Socket Screw M8 x 25	35	Crank Handle
6	Washer	36	Bolt
7	Rear Belt Door	37	Cam Follower Tailstock
8	Twist Knob	38	Bed
9	Stationary Knob	39	Retaining Plate
10	Bolt	40	Hex Socket Screw M10 x 12
11	Screw	41	Lock Plate
12	Headstock	42	Nut M10
13	Circlip	43	n/a
14	Headstock Spindle	44	n/a
15	Faceplate	45	n/a
16	Headstock Spur Centre	46	Lock Screw
17	Locking Handle	47	Hex Socket Screw M8 x 12
18	Circlip	48	Motor Plate
19	Tool Rest Bushing	49	Big Washer
20	Tool Rest (150mm)	50	Washer 6
21	Tool Rest Base	51	Motor Pulley
22	Tool Rest Cam Follower	52	Drive Pulley
23	Flat Head Screw	53	Drive Belt
24	Spring	54	Bolt
25	Handle	55	Washer
26	Lock Bolt	56	Door Latch
27	Cup Centre	57	Washer 4
28	Ball Bearing 80102	58	Hinge
29	Taper Rod	59	Screw M4 x 6
30	Tailstock Quill	60	Switch Box Plate
61	Hinge Pin	71	Rubber Washer
62	Power Cable	72	Nut M10

PART NO	DESCRIPTION	PART NO	DESCRIPTION
63	Overload Protector	73	Circlip
64	Circuit Board	74	Washer
65	Screw M4 x 6	75	Flat Head Screw
66	Switch Box	76	Cover
67	Variable Speed Knob	77	Variable Plate
68	On/Off Switch	78	Screw
69	Hex Socket Taper Screw M6 x 12	79	Transformer
70	Motor		

## ASSOCIATED PRODUCTS

Wood Turning Chisel Set - CHT874	4 Sided Diamond Sharpener - CHT593	SAE30 Motor Oil - 1 litre
		
<ul style="list-style-type: none"> <li>• 8 piece wood turning chisel set</li> <li>• Part No. 1801874</li> </ul>	<ul style="list-style-type: none"> <li>• Multi-purpose sharpener with four different grits</li> <li>• Part No. 1801593</li> </ul>	<ul style="list-style-type: none"> <li>• For lubricating tailstock &amp; screw threads</li> <li>• Part No. 3050852</li> </ul>



## TROUBLESHOOTING

Problem	Check	Solution
Motor stops and will not run.	<ol style="list-style-type: none"> <li>1. Defective/broken on/off switch.</li> <li>2. Damaged power cable.</li> <li>3. Open circuit, loose connections or burned out motor.</li> <li>4. Blown fuse or circuit breaker.</li> <li>5. Low voltage.</li> </ol>	<p>Send to your CLARKE dealer for repair.</p> <p>Send to your CLARKE dealer for replacement.</p> <p>Send to your CLARKE dealer for replacement.</p> <p>Replace fuse or re-set circuit breaker. Turn off other machines on same circuit. Check the power supply for correct voltage. Use another circuit or have a qualified electrician upgrade the power supply.</p>
Motor will not start and fuses or circuit breaker trip out.	<ol style="list-style-type: none"> <li>1. Short circuit in motor or power cable.</li> <li>2. Incorrect fuses or circuit breakers.</li> </ol>	<p>Send to your CLARKE dealer for repair.</p> <p>Replace with correct fuse or circuit breaker for the circuit.</p>
Motor fails to reach full power.	<ol style="list-style-type: none"> <li>1. Overloaded circuit.</li> <li>2. Unsuitable extension cable</li> </ol>	<p>Turn off other machines &amp; retry.</p> <p>Replace with correct size extension cable.</p>
Noisy operation	<ol style="list-style-type: none"> <li>1. Incorrect belt tension.</li> <li>2. Dry spindle.</li> <li>3. Loose drive pulley.</li> </ol>	<p>Adjust belt tension. See Replacing the Belt on page 12</p> <p>Lubricate the spindle.</p> <p>Tighten the retaining set-screw on the pulley.</p>

# DECLARATION OF CONFORMITY



Hemncill Street, Epping, Essex CM16 4LG

## DECLARATION OF CONFORMITY

This is an important document and should be retained.

We hereby declare that this product(s) complies with the following UK legislation:

*Electromagnetic Compatibility Regulations 2016.*

*Supply of Machinery (Safety) Regulations 2008.*

*The Restriction of the Use of Certain Hazardous Substances  
in Electrical and Electronic Equipment Regulations 2012.*

The following standards have been applied to the product(s):

*EN 61029-1:2009+A11:2010, EN 61000-3-2:2014, EN 61000-3-3:2013, EN 55014-2:2015,  
EN 55014-1:2006+A1:2009+A2:2011.*

The technical documentation required to demonstrate that the product(s) meet(s) the requirement(s) of the aforementioned legislation has been compiled and is available for inspection by the relevant enforcement authorities.

This product was placed onto the market: 2021

**Product Description:** 550W Wood Lathe  
**Model number(s):** CWL460  
**Serial / batch Number:** N/A  
**Date of Issue:** 16/02/2021

**Signed:**

J.A. Clarke  
Director

# DECLARATION OF CONFORMITY



**Clarke**<sup>®</sup>  
**INTERNATIONAL**

Fitzwilliam Hall, Fitzwilliam Place, Dublin 2

## DECLARATION OF CONFORMITY

This is an important document and should be retained.

We hereby declare that this product(s) complies with the following directive(s):

- 2014/30/EU      *Electromagnetic Compatibility Directive.*  
2006/42/EC      *Machinery Directive.*  
2011/65/EU      *Restriction of Hazardous Substances, (amended by 2015/863).*

The following standards have been applied to the product(s):

- EN 61029-1:2009+A11:2010, EN 61000-3-2:2014, EN 61000-3-3:2013, EN 55014-2:2015,  
EN 55014-1:2006+A1:2009+A2:2011.*

The technical documentation required to demonstrate that the product(s) meet(s) the requirement(s) of the aforementioned directive(s) has been compiled and is available for inspection by the relevant enforcement authorities.

The CE mark was first applied in: 2021

**Product Description:**            550W Wood Lathe  
**Model number(s):**                CWL460  
**Serial / batch Number:**        N/A  
**Date of Issue:**                    16/02/2021

Signed:

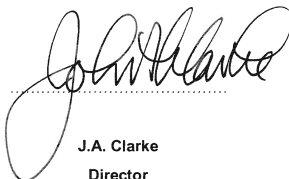

J.A. Clarke  
Director

# A SELECTION FROM THE VAST RANGE OF

# Clarke®

## QUALITY PRODUCTS



### **AIR COMPRESSORS**

From DIY to industrial, Plus air tools, spray guns and accessories.

### **GENERATORS**

Prime duty or emergency standby for business, home and leisure.

### **POWER WASHERS**

Hot and cold, electric and engine driven - we have what you need

### **WELDERS**

Mig, Arc, Tig and Spot. From DIY to auto/industrial.

### **METALWORKING**

Drills, grinders and saws for DIY and professional use.

### **WOODWORKING**

Saws, sanders, lathes, mortisers and dust extraction.

### **HYDRAULICS**

Cranes, body repair kits, transmission jacks for all types of workshop use.

### **WATER PUMPS**

Submersible, electric and engine driven for DIY, agriculture and industry.

### **POWERTOOLS**

Angle grinders, cordless drill sets, saws and sanders.

### **STARTERS/CHARGERS**

All sizes for car and commercial use.

# **PARTS & SERVICE: 0208 988 7400**

---

**Parts Enquiries**  
[Parts@clarkeinternational.com](mailto:Parts@clarkeinternational.com)

---

**Servicing & Technical Enquiries**  
[Service@clarkeinternational.com](mailto:Service@clarkeinternational.com)

---

SALES: UK 01992 565333 or Export 00 44 (0)1992 565335

**Clarke®** INTERNATIONAL Hemnall Street, Epping, Essex CM16 4LG  
[www.clarkeinternational.com](http://www.clarkeinternational.com)